

FITTING PLATES

P1026

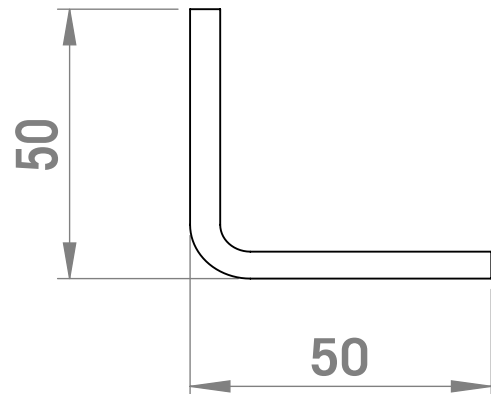
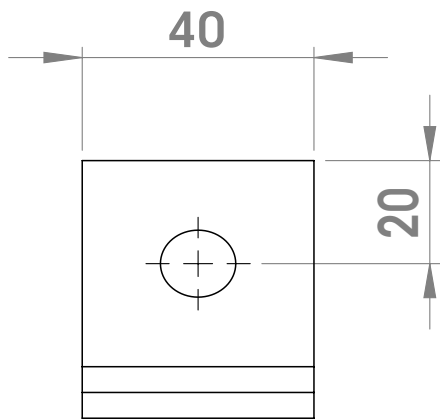
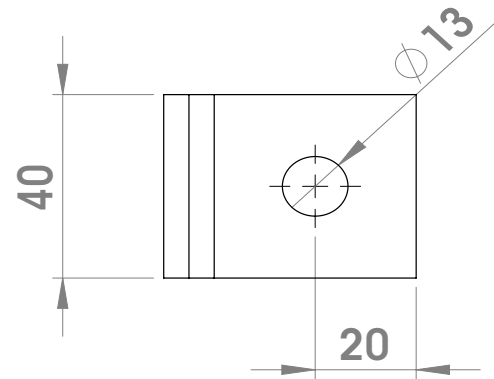
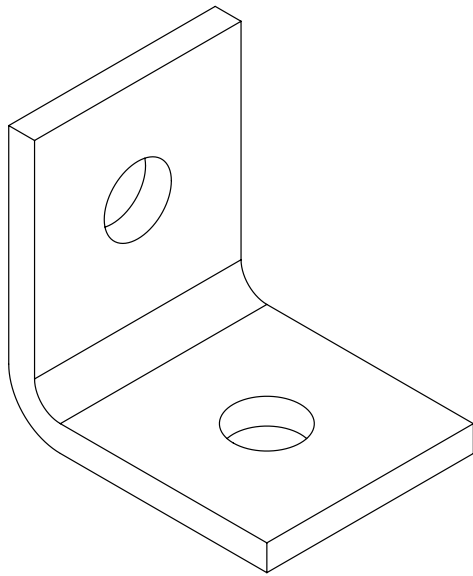

CODE	DESCRIPTION	THICKNESS[mm]	MATERIAL
P10265ZE	Angular Fitting	5,0	ZE
P10266ZE	Angular Fitting	6,0	ZE
P10265ZC	Angular Fitting	5,0	ZC
P10266ZC	Angular Fitting	6,0	ZC

Available also in Stainless steel A304 and A316

Legend:

ZE= GALVANIZED

ZC= HOT DIP GALVANIZED