

FITTING PLATES

P2787

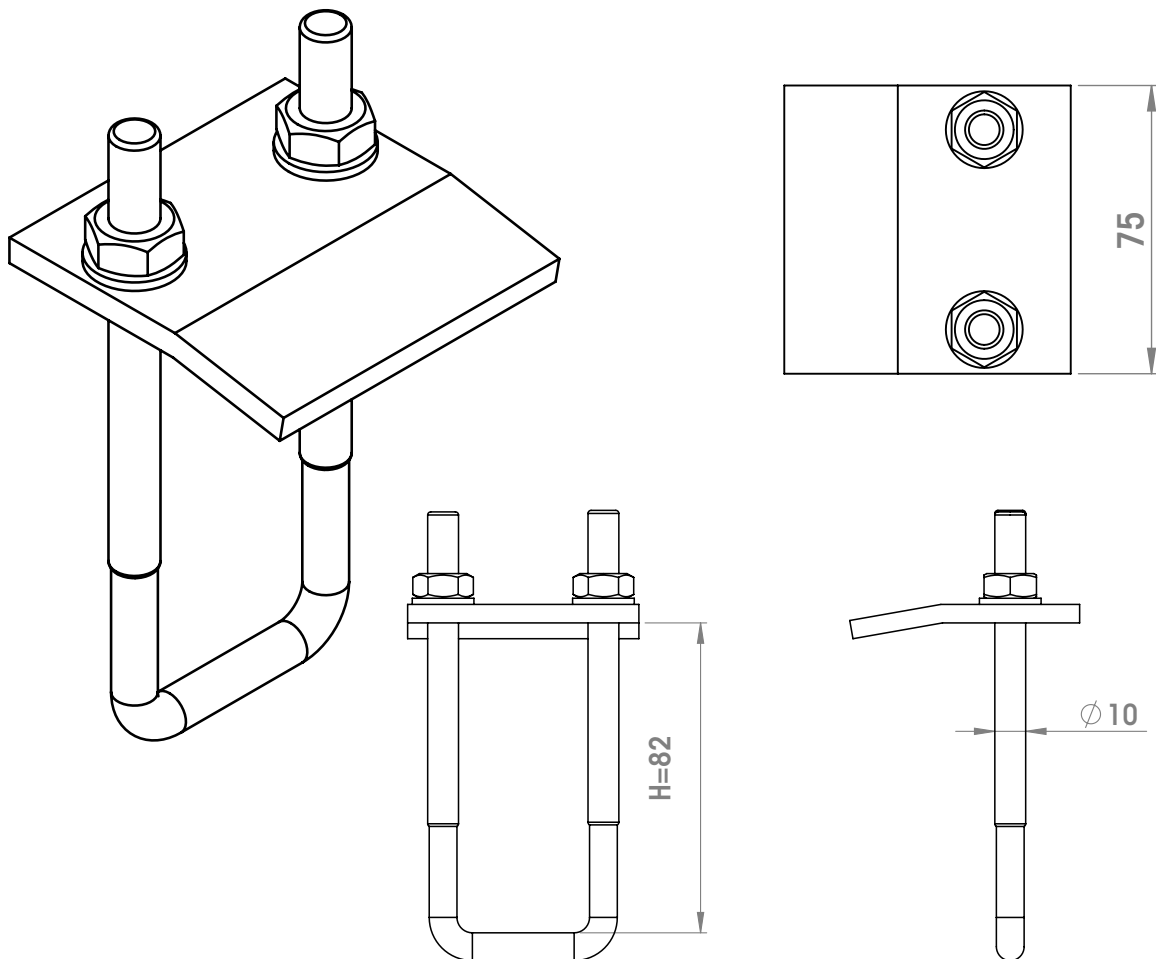

CODE	DESCRIPTION	THICKNESS[mm]	MATERIAL
P27876ZE	Beam Clamp	6,0	ZE
P27876ZC	Beam Clamp	6,0	ZC

Available also in Stainless stell A304 and A316

Legend:
 ZE= GALVANIZED
 ZC= HOT DIP GALVANIZED