

FITTING PLATES

P2071

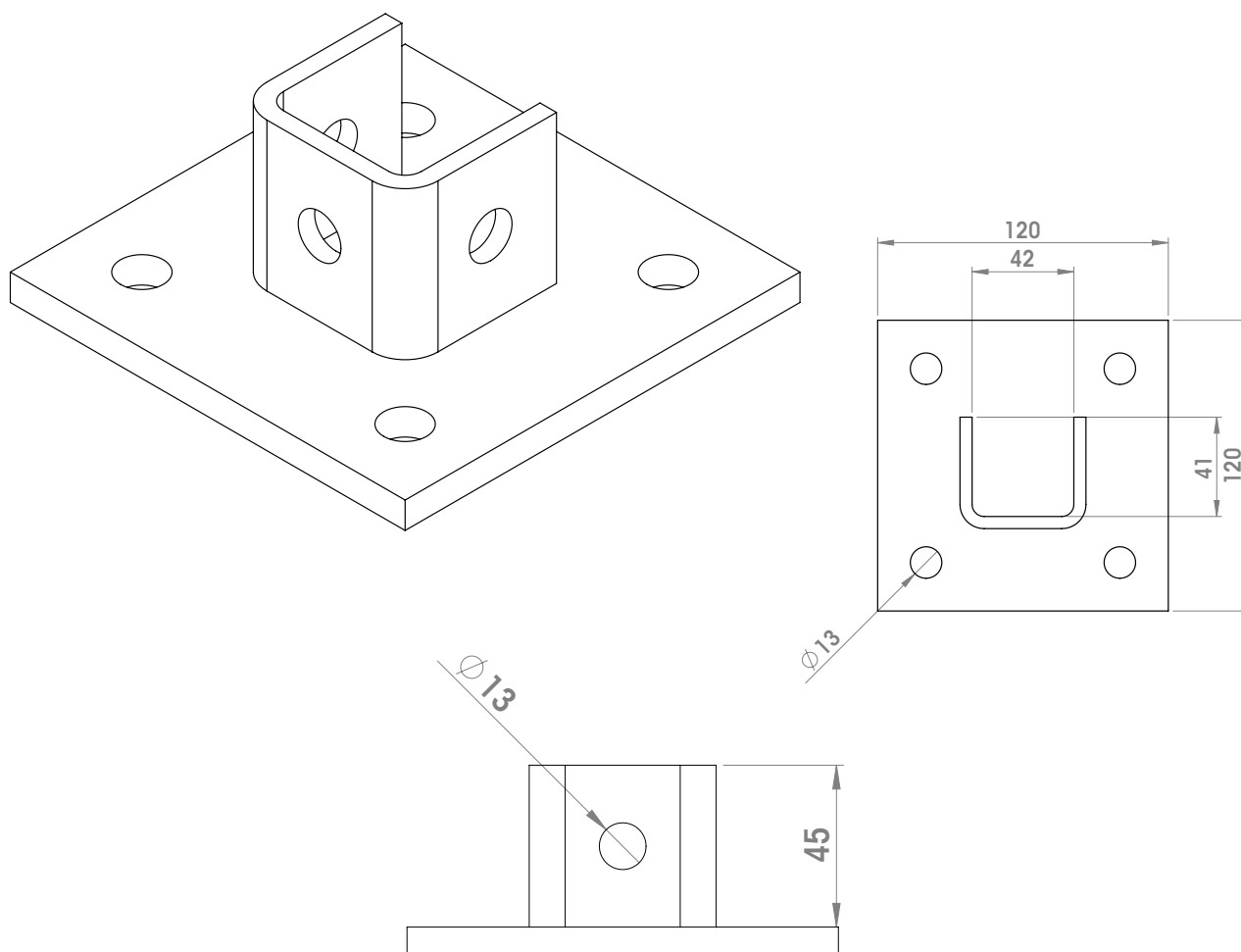

CODE	DESCRIPTION	THICKNESS[mm]	MATERIAL
P20715ZE	Base plate	5,0	ZE
P20716ZE	Base plate	6,0	ZE
P20715ZC	Base plate	5,0	ZC
P20716ZC	Base plate	6,0	ZC

Available also in Stainless steel A304 and A316

Legend:

ZE= GALVANIZED

ZC= HOT DIP GALVANIZED