

FITTING PLATES

P1067

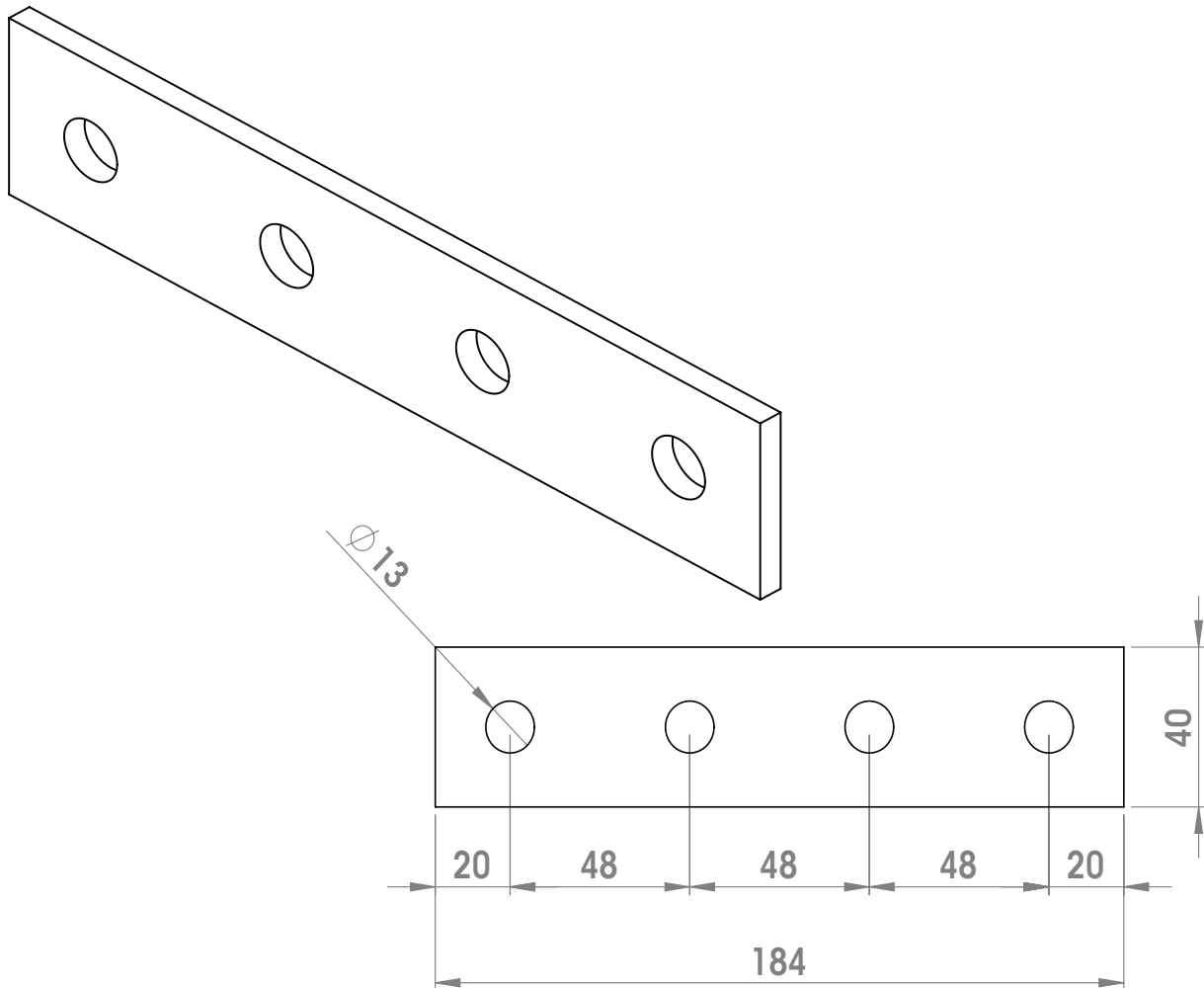

CODE	DESCRIPTION	THICKNESS[mm]	MATERIAL
P10675ZE	Flat Fitting	5,0	ZE
P10676ZE	Flat Fitting	6,0	ZE
P10675ZC	Flat Fitting	5,0	ZC
P10676ZC	Flat Fitting	6,0	ZC

Available also in Stainless steel A304 and A316

Legend:

ZE= GALVANIZED

ZC= HOT DIP GALVANIZED