

FITTING PLATES

P2072

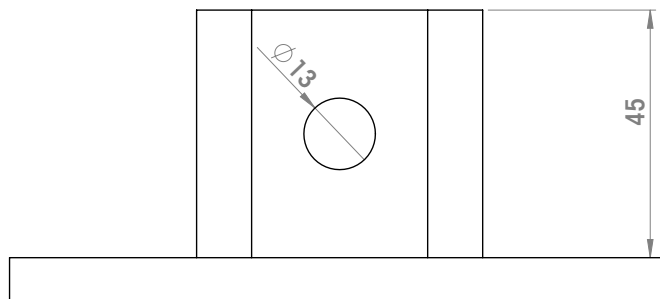
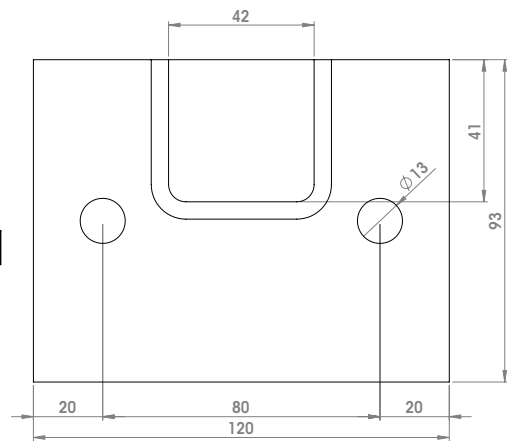
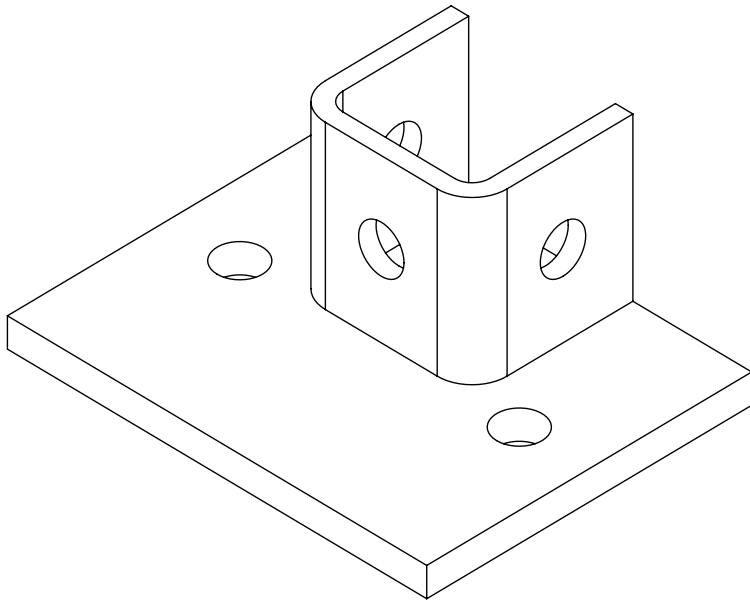

CODE	DESCRIPTION	THICKNESS[mm]	MATERIAL
P20725ZE	Base plate	5,0	ZE
P20726ZE	Base plate	6,0	ZE
P20725ZC	Base plate	5,0	ZC
P20726ZC	Base plate	6,0	ZC

Available also in Stainless steel A304 and A316

Legend:

ZE= GALVANIZED

ZC= HOT DIP GALVANIZED