

FITTING PLATES

P2484

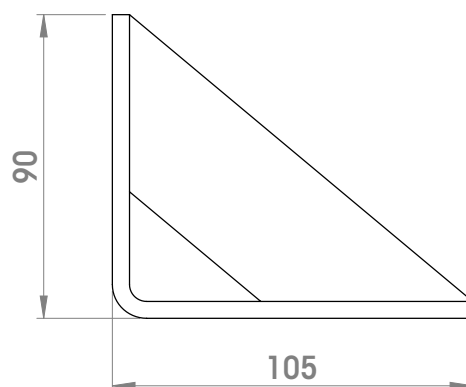
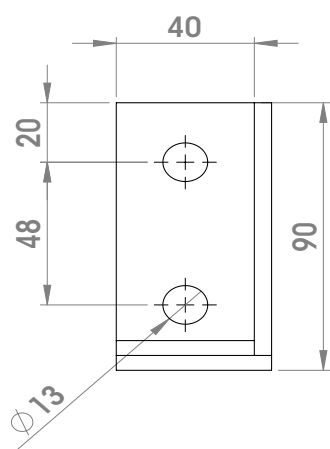
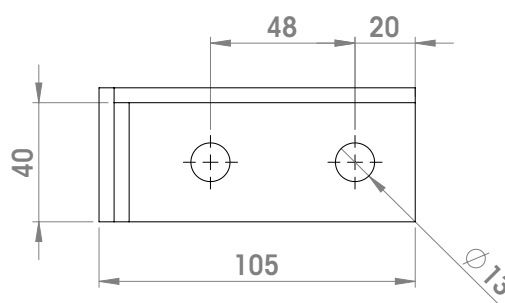
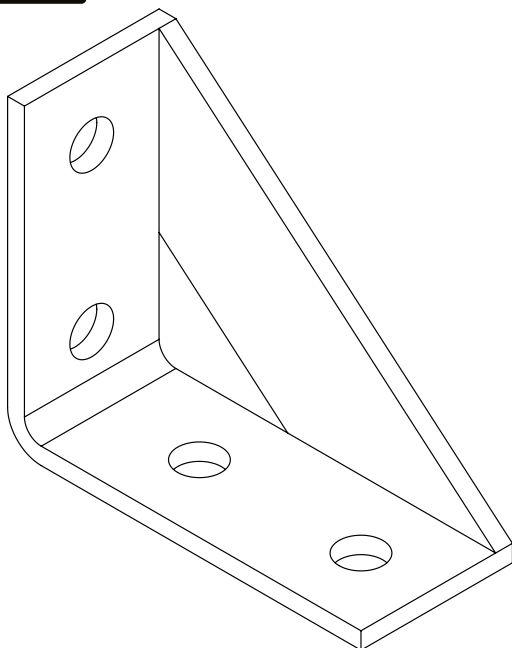

CODE	DESCRIPTION	THICKNESS[mm]	MATERIAL
P24845ZE	Angular Fitting	5,0	ZE
P24846ZE	Angular Fitting	6,0	ZE
P24845ZC	Angular Fitting	5,0	ZC
P24846ZC	Angular Fitting	6,0	ZC

Available also in Stainless steel A304 and A316

Legend:

ZE= GALVANIZED

ZC= HOT DIP GALVANIZED